



FOOD



LINEA FOOD



LINEA DRINK

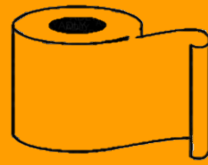

LINEA IGIENE E SEVIZI



SANITA'

CATALOGO

CATALOGO 2025

CATALOGO

CATALOGO

CATALOGO

CATALOGO

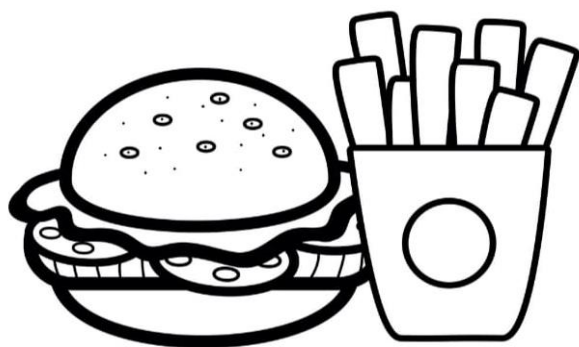

FOOD

IL TUO
PREZZO
IVATO



COD.	PRODOTTO	CONF.	QUANTITA PER CARTONE	
M13930G	TOMATO KETCHUP DEVELEY IN BUSTINE MONOPORZIONE 15ML	PZ 100	 CONF.4	8,30 €
M14080H	MAIONESE DI GIRASOLE DEVELEY IN BUSTINE MONOPORZIONE 15ML	PZ 100	 CONF. 4	9,80 €
M14120I	SALSA BARBECUE DEVELEY IN BUSTINE MONOPORZIONE 20ML	PZ 100	 CONF. 4	10,20 €
M14275C	TOMATO KETCHUP DEVELEY IN SCATOLO DA 8 FLACONI 875ML 1010G		 CONF. 8	4,25 €
M14870D	MAIONESE DEVELEY IN SCATOLO DA 8 FLACONI 875ML 1010G		 CONF. 8	5,25 €
M14470B	SENAPE DEVELEY IN SCATOLO DA 8 FLACONI 875ML 1010G		 CONF. 8	3,30 €
M14510D	SALSA BARBECUE DEVELEY IN SCATOLO DA 8 FLACONI 875ML 1010G		 CONF. 8	4,60 €
M14630D	SALSA ROSA DEVELEY IN SCATOLO DA 8 FLACONI 875ML 1010G		 CONF. 8	4,85 €
M14750D	SALSA CHEDDAR DEVELEY IN SCATOLO DA 8 FLACONI 875ML 1010G		 CONF. 8	5,10 €







M14330D	SALSA CHILI DEVELEY IN SCATOLO DA 8 FLACONI 875ML 1010G			CONF. 8	5,10 €
M14915D	SALSA HAMBURGER DEVELEY IN SCATOLO DA 8 FLACONI 875ML 1010G			CONF. 8	4,80 €
M15065B	DRESSING YOGURT IN BOTTIGLIA 500ML	PZ 1		CONF. 12	3,20 €
M15165B	DRESSING CONDIMENTO ALLE ERBETTE IN BOTTIGLIA DA 500ML	PZ 1		CONF. 12	3,20 €
M15266B	DRESSING CONDIMENTO CAESAR IN BOTTIGLIA DA 500ML	PZ 1		CONF. 12	3,20 €
M15365B	DRESSING CONDIMENTO TZATZIKI IN BOTTIGLIA DA 500ML	PZ 1		CONF. 12	3,20 €
M15495B	TABASCO IN BOTTIGLIETTA DA 60ML	PZ 1		CONF. 12	3,48 €

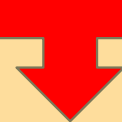

**LINEA
FOOD**

**IL TUO
PREZZO
IVATO**



COD.	PRODOTTO	CONF.	QUANTITA PER CARTONE	
G15527A	FORCHETTE BIODEGRADABILI MONOUSO	PZ 50	 CONF.40	2,22 €
P05170D	FORCHETTE IN PLASTICA DOPLA' REUSE TRASP	PZ 100	 CONF. 10	5,85 €
G05325B	FORCHETTE BIO COMPOST BIANCHE	PZ 50	 CONF. 20	2,84 €
M09879D	CUCCHIAIO PP GRANITA 13/14 CM RIUTILIZZABILE	KG 1	 CONF. 5	6,08 €
M05501B	CUCCHIAINI MIGNON IN LEGNO 11 CM	PZ 100	 CONF. 50	2,72 €
M05646B	CUCCHIAI MEDI IN LEGNO 14 CM	PZ 100	 CONF. 50	3,16 €
C26029C	CUCCHIAI GRANDE IN LEGNO 16 CM	PZ 100	 CONF. 20	8,65 €
M07124B	FORCHETTINE PICCOLE IN LEGNO 10,5CM	PZ 100	 CONF. 50	2,92 €
M11690B	FORCHETTA IN LEGNO 16 CM	PZ 100	 CONF.10	3,60 €
M07245F	KIT POSATE IN LEGNO COLTELLO FORCHETTA CUCCHIAIO E TOVAGLIOLO	PZ 50	 CONF. 10	8,06 €
G09668CC	BUSTE PORTA POSATE IN CARTA BIANCA	PZ 1000	 CONF.1	48,85 €
G09768CF	BUSTE PORTA POSATE IN CARTA PAGLIA	PZ 1000	 CONF. 1	49,90 €
M02833M	PALETTINE CAFFE LEGNO 9X0,6X0,1CM IMBUSTATE SINGOLARMENTE	PZ 50	 CONF. 500	0,49 €



G19284B	PIATTI BIO POLPA FRUTTA DM18 X 50 PZ	PZ 50		CONF.20	3,84 €
G08115B	PIATTI ELITE RIUTILIZZABILI PIANI	PZ 50		CONF. 16	2,69 €
M11075D	PIATTI BIO ROTONDI 18 CM	PZ 50		CONF. 10	5,80 €
M03380M	PIATTI DESSERT BIANCHI RIUTILIZZABILI	PZ 25		CONF.30	1,08 €
P1635C	FORCHETTINE IN PP A DUE PUNTE PATATINE FRITTE TRASP 500GG	500 G		CONF.10	6,50 €
M07900BM	TOVAGLIOLI 20X20CM VELINA PER ALIMENTI KG9 S/GREEN			KG 9	24,90 €
M08064BA	TOVAGLIOLI 20X20CM VELINA PER ALIMENTI KG9 S/BLU			KG 9	29,50 €
C21905BD	TOVAGLIOLI VELINA 20X20 DA 10KG			KG 10	29,90 €
M09300BC	BUSTE CARTA PER FRUTTA E VERDURA 17X40 CM KG 10	KG 10		CONF.3	27,45 €
M05093C	TOVAGLIOLI 17X17CM BIANCHI PER DISPENSER	PZ 2000		CONF. 8	5,45 €
C01294M	TOVAGLIOLI NERI 24X24	PZ 100		CONF. 24	1,85 €
C01394M	TOVAGLIOLI VARI COLORI DA CHIEDERE PRIMA DELL'ORDINE 24X24	PZ 100		CONF. 24	1,85 €
C01494M	TOVAGLIOLI VERDE 24X24	PZ 100		CONF. 24	1,85 €
C27066M	TOVAGLIOLI BIANCO 24X24 CONF 100 SCATOLO DA 24	PZ 100		CONF 30	1,36 €
M10510E	TOVAGLIOLI IN CARTA TESSUTO 40X40 CM EASY N°50 VARI COLORI	PZ 50		CONF. 12	6,07 €
M22610C	TOVAGLIOLI FIBRA 40X40 4 VELI COLORE CAPPUCCINO/CORDA	PZ 50		CONF. 24	4,78 €
G09464G	TOVAGLIETTA MONOPOSTO IN CARTA PAGLIA DA 33X40	PZ 500		CONF. 5	10,80 €
C16290C	TOVAGLIA SEGNA POSTO IN CARTA PAGLIA N°250	PZ 250		CONF. 8	6,77 €

M09580G	TOVAGLIETTA IN CARTA CON STAMPA MARINARESCA/MAIOLICA E VARIE DA 30X40	PZ 500		CONF.5	10,09 €
M08250AA	TOVAGLIA IN CARTA TESSUTO 100X100 CM COLORE TORTORA E VARI COLORI	PZ 20		CONF. 5	14,30 €
M083040E	TOVAGLIA DA TAVOLA 100X100 CM COLORE CHAMPAGNE E VARI COLORI	PZ 25	8,65 € 	CONF.4	7,90 €
C22585AG	COPRIMACCHIA TNT 100 X 100 X 20 PZ VARI COLORI	PZ 100		CONF. 1	31,60 €
M08441A	TOVAGLIOLO FIBRA 38X38 PUNTA A PUNTA CM DOPPIO VELO COLORE MARRONE O ALTRI COLORI	PZ 40		CONF.36	1,90 €
G08502A	TOVAGLIOLI 38X38 CM PUNTA A PUNTA COLORE CIOCCOLATO/ MARRONE E VARI COLORI	PZ 40		CONF. 42	1,90 €
G10783M	TOVAGLIOLO SOFFICE 33X33 CREMA O VARI COLORI	PZ 50		CONF. 24	1,48 €
C08671M	TOVAGLIOLI DOPPIO VELO 38X38 CM PUNTA A PUNTA BIANCO	PZ 40		CONF.42	1,14 €
G19475B	TOVAGLIOLI 1V 30X30 X 500 PZ	PZ 500		CONF. 8	3,99 €
C16733B	TOVAGLIOLI MONOVELO 33X30 BIANCHI	PZ 400		CONF. 15	3,60 €
G19620AB	BOX PIZZA 29X29 B.CO/AVANA/STAMP X 80PZ	PZ 80		CONF. 3	15,95 €
G19502AD	BOX PIZZA 33X33 B,CO/AVANA/STAMP X80 PZ	PZ 80		CONF. 3	18,15 €
G23978AA	BOX PIZZA 29X29 B.CO/ AVANA CUBO NO COPERCHIO X 95 PZ			CONF. 3	15,45 €
G19793AA	BOX PIZZA 33X33 CUBO X95 PZ	PZ 95		CONF. 3	15,90 €
G19831BE	BOX PIZZA 45X45 B.CO/AVANA/STAMP X 80 PZ	PZ 80		CONF. 3	34,50 €
M04291AF	BOX PIZZA COPERCHIO 33X33	PZ 80		CONF. 3	20,86 €
M12870AG	BOX PIZZA 31X31 CM BIANCO CON STAMPA	PZ 80		CONF 3	20,45 €
M12507AE	BOX PIZZA BIANCO 29X29	PZ 80		CONF. 3	18,90 €

M04380AE	BOX PIZZA CUBO 33X33	PZ 90		CONF. 3	18,70 €
M04400CD	BOX PIZZA RETTANGOLARE COPERCHIO 30X58	PZ 80		CONF. 3	37,65 €
M04528CB	BOX PIZZA FAMILIARE 45X45	PZ 80		CONF. 3	37,80 €
M16900CA	SCATOLA PORTA HAMBURGER 19X18X9CM	PZ 100		CONF. 3	36,49 €
G27387BE	BOX POLLO IN CONFEZIONE DA 100	PZ100		CONF. 1	31,87 €
C06533C	VASCHETTA OPS 500CC RETTANGOLARE CON COPERCHIO TRASP	PZ 50		CONF 12	5,48 €
C11717E	VASCHETTA OPS 750 CC RETTANGOLARE CON COPERCHIO	PZ 50		CONF. 4	7,65 €
C11849E	VASCHETTA OPS 1000 CC RETTANGOLARE CON COPERCHIO	PZ 50		CONF.8	8,50 €
C25194G	VASCHETTE OPS 1500CC RETTANGOLARE CON COPERCHIO TRASP.	PZ 50		CONF.5	10,80 €
M25225I	VASCHETTA ALLUMINIO 6P SENZA COPERCHIO	PZ 50		CONF. 7	12,09 €
C04732AA	VASCHETTE ALLUMINIO DA 4 PORZIONI CON COPERCHIO	PZ 100		CONF. 3	17,35 €
M04979D	VASCHETTA ALLUMINIO DA 4 PORZIONI SENZA COPERCHIO	PZ 50		CONF. 3	7,85 €
G19952AB	VASCHETTE ALLUMINIO DA 4 PORZIONI PREDISPOSTA PER COPERCHIO PZ 100	PZ 100		CONF. 3	16,38 €
C21817E	COPERCHI PER VASCHETTE PREDISPOSTE IN ALLUMINIO 4 PORZIONI	PZ 100		CONF. 3	7,38 €
C20036H	VASCHETTA ALLUMINIO DA 4 PORZIONI SENZA COPERCHIO N°100	PZ 100		CONF. 3	13,35 €
M22420AD	VASCHETTE ALLUMINIO DA 1,5 PORZIONI CON COPERCHIO	PZ 100		CONF. 3	19,40 €
C24136I	VASCHETTA POLISTIROLO 222 23,5X18,5X3,4CM COLORE BIANCO	PZ 100		CONF. 4	15,79 €
C24650AB	VASCHETTA POLISTIROLO 204 27X18,5X1,5CM COLORE BIANCO	PZ 125		CONF. 4	16,25 €

C24548AB	VASCETTA POLISTIROLO 203 23,5X16X2CM COLORE BIANCO	PZ 166		CONF. 6	16,22 €
P24099F	VASCETTA POLISTIROLO 202 20X13,5X1,8CM COLORE BIANCO	PZ 125		CONF. 8	9,35 €
C24498AA	VASCETTA POLISTIROLO 172 29X21,5X4,5CM COLORE BIANCO	PZ 75		CONF. 4	14,62 €
C24766AM	VASCETTA POLISTIROLO 168 27X17X5,2CM COLORE BIANCO	PZ 100		CONF. 5	13,98 €
C24245H	VASCETTA POLISTIROLO 166 24X16X4CM COLORE BIANCO	PZ 100		CONF. 6	10,56 €
C14311F	VASCETTA POLISTIROLO 162 22,5X14,5X2,5CM COLORE BIANCO	PZ 100		CONF. 5	9,30 €
C25309AD	CARTENE FOGLIO HD A STRAPPO 37X50CM	KG 5		CONF 1	19,09 €
C06606AD	CARTENE A STRAPPO MEZZO F. 25X37 5KG	KG 5		CONF 3	19,09 €
G17085B	SACCHETTI GELO POLITILENE TRASPARENTE 40X60	KG 1		KG 5	5,50 €
G08915CF	PELLICOLA ALIMENTARE 45CM 1500MT	ML1500		PZ 1	44,15 €
G20151C	PELLICOLA PER ALIMENTI 300MT HT 30	MT 300		CONF.6	5,00 €
M16670E	PELLICOLA PER ALIMENTI 300MT H 30CM COLORE CHAMPAGNE	PZ 1		CONF. 6	7,20 €
M23379C	PELLICOLA ALIMENTARE IN PVC COLORE VERDE			CONF. 6	5,87 €
C09069E	ALLUMINIO IN ROTOLO MT 100 X CM 30	PZ 1		CONF. 3	7,86 €
M09010G	ALLUMINIO IN ROTOLO 33CM 12MY KG1	PZ 1		CONF. 3	8,79 €
M22390D	CARTA FORNO A ROTOLO H40CM 50MT	50MT		CONF. 3	6,45 €
C22114BA	CARTA FORNO A FOGLIO 40X60 KG 5	KG 5		CONF. 3	26,55 €
C27220AB	DISCHI HAMBURGER IN CARTA FORNO CM 10	KG 1		CONF.12	16,85 €

C25598D	BUSTE SOTTOVUOTO GOFFRATO. 16X25X100PZ	PZ 100		CONF. 10	7,97 €
C24864E	BUSTE SOTTOVUOTO GOFFRATO. 15X30CM	PZ 100		CONF. 10	8,68 €
G26502I	BUSTE SOTTOVUOTO GOFFRATE 15X40	PZ 100		CONF. 10	12,65 €
C23851G	BUSTE DA SOTTOVUOTO GOFFRATE 20X30CM	PZ 100		CONF. 10	11,28 €
C05750AA	BUSTE DA SOTTOVUOTO GOFFRATE 25X35 CM	PZ 100		CONF. 5	15,34 €
C21703AE	BUSTE DA SOTTOVUOTO GOFFRATE 30X40 CM	PZ 100		CONF.5	19,69 €
M24965AD	BUSTE SOTTOVUOTO GOFFRATO. 25X40CM	PZ 100		CONF. 5	18,10 €
M09272AA	BUSTE SOTTOVUOTO GOFFRATE 20X40CM N°100	PZ 100		CONF.5	15,65 €
G25036AG	BUSTE SOTTOVUOTO GOFFRATO. 40X60CM	PZ 50		CONF. 5	22,90 €
N11250A	STECCHONE SPADA/ BANDIERA 18 CMM	PZ 100		CONF. 15	2,30 €
M07350G	CONO LEGNO PER ALIMENTI H18,5CM	PZ 100		CONF. 10	9,58 €
M09930AM	CONO IN LEGNO CM 9,5X H 22	PZ 100		CONF. 20	11,90 €
M07400E	CONO IN CARTONCINO H22,5CM PER FRITTURE	PZ 50		CONF. 10	5,99 €
P17479E	CONI IN CARTA PAGLIA 19X19X27 100 PZ	PZ 100		CONF. 20	6,19 €
M08879D	BARCETTA IN LEGNO 9X6 CM	PZ 100		CONF. 10	5,55 €
M16470E	BARCETTA IN LEGNO 14X8 CM	PZ 100		CONF. 10	7,32 €
M12430H	BOX PER PATATINE FRITTE RIVESTIRO MAXI 130X9,5.3,5 N° 100	PZ 100		CONF. 8	10,15 €









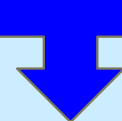



M07560A	BARCETTA DI CARTONCINO 10,5 CM	PZ 50		CONF. 20	1,99 €
M07670A	BARCETTA DI CARTONCINO 13 CM	PZ 50		CONF. 20	2,04 €
M07750D	BARCETTA DI CARTONCINO 20X12,5 CM	PZ 50		CONF. 10	5,45 €
M07865E	BARCETTA DI CARTONCINO 22,5X14 CM	PZ 50		CONF. 12	6,78 €



**LINEA
DRINK**

IL TUO
PREZZO
IVATO



COD.	PRODOTTO	CONF.	QUANTITA PER CARTONE	
C00191B	BICCHIERI PET 575 CC TACCA A 0,4 TRASPARENTI ARISTEA NATURIA	PZ 50	 CONF. 16	3,99 €
P17630B	BICCHIERI PET 500 CC TACCA A 0,4 TRASPARENTI ARISTEA NATURIA	PZ 50	 CONF. 20	2,82 €
C00293A	BICCHIERI 400CC TACCA 0,3 TRASP ARISTEA NATURIA	PZ 50	 CONF. 20	2,72 €
C00373A	BICCHIERI 350CC TACCA 0,3 ARISTEA NATURIA	PZ 50	 CONF. 20	2,46 €
G10892A	BICCHIERE 350 CC TACCA 0,3 TRASP ARISTEA SLIM	PZ 50	 CONF. 25	2,80 €
P00439A	BICCHIERI 355 CC SLIM TRASP ISAP	PZ 30	 CONF. 30	1,79 €
C00542A	BICCHIERI 300CC TACCA 0,25 ARISTEA NATURIA	PZ 50	 CONF. 20	1,99 €
M11550A	BICCHIERI 300 CC ARISTEA TUBO	PZ 30	 CONF. 20	1,89 €
C00627A	BICCHIERI DA 250CC TACCA 0,2 TRASP ARISTEA NATURIA	PZ 50	 CONF. 20	1,99 €
C00712A	BICCHIERI DA 202CC ARISTEA NATURIA	PZ 50	 CONF. 20	2,06 €
C21154A	BICCHIERI CRISTAL 160CC 50X20	PZ50	 CONF. 20	1,96 €
G20477A	BICCHIERINO LIQUORE SHOT CC 20 50X 40	PZ 50	 CONF. 40	2,15 €
P04838B	BICCHIERI CICCHETTI DA DEGUSTAZIONE ISAP	PZ 80	 CONF. 45	3,06 €

C00950A	BICCHIERINI TRASP 20 CC ELITE SHOTS TEQUILA FORMA OTTAGONALE	PZ 50		CONF. 40	2,22 €
M01050D	CANNUCCE BIO NERE DRITTE H21-CM	PZ 500		CONF. 6	5,96 €
G03895C	CANNUCCE 7X21 NERE N1000	1000		CONF. 10	6,49 €
P15639F	CANNUCCE NERE CM21 BYO	500		CONF. 20	7,95 €
G18988B	CANNUCCE NERE 13CMX1000PZ	1000		CONF.10	5,90 €
M175298C	CANNUCCE DRITTE IN CARTA NERA STRISCIA BIANCA 8X200 MM N°250	250		CONF.10	4,78 €
M11300E	CANNUCCE IN CARTA MULTICOLOR 20X07 CM	PZ 250		CONF. 10	6,60 €
M01165M	BICCHIERI ACQUA TRASP/B. 200 CC ELITE	PZ 80		CONF.30	1,02 €
C011018A	BICCHIERI ACQUA TRASP 200CC	PZ 100		CONF.30	31,00 €
M05210A	BICCHIERI IN CARTONCINO 210CC BIANCHI	PZ 50		CONF.20	1,45 €
C02747M	BICCHIERI CAFFE' IN CARTONCINO 75 ML	PZ 50		CONF.30	0,86 €
M19169M	BICCHIERINI CAFFE DA 80CC VARI COLORI PZ 50	PZ 50		CONF.48	1,05 €

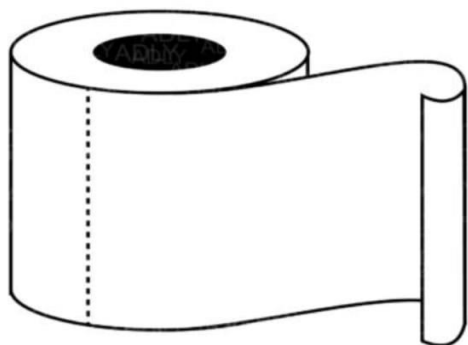















LINEA IGIENE E SERVIZI



IL TUO
PREZZO
IVATO



COD.	PRODOTTO	CONF.	QUANTITA PER CARTONE	
M02120C	ROTOLONE ASCIUGATUTTO PURA CELLULOSA	PZ 2	 CONF. 2	4,20 €
C26936D	ROTOLONE BOBINA MULTIUSO PROFESSIONALE	PZ 2	 CONF. 2	7,76 €
C05464E	ROTOLONE BOBINA MULTIUSO PROFESSIONALE	PZ 2	 CONF. 2	9,20 €
G05450E	ASCIUGATUTTO BOBINA IL ROTOLONE PROFESSIONALE	PZ 2	 CONF. 2	9,65 € 13,00 €
C06484M	VELINE MULTIUSO SOAVEX IN PURA OVATTA DI CELLULOSA 2 VELI	N°100	 CONF. 40	1,22 €
C22791AF	ASCIUGAMANI MONOUSO PIEGATI A V PZ 210 CONF.15	SCT 1	 CONF. 15	24,49 €
M03958BM	ASCIUGAMANI MONOUSO PIEGATI AC AZ PZ 210 CONF N°15	SCT 1	 CONF. 15	26,10 €
M27546AC	CARTA IGIENICA MAXI JUMBO PURA CELLULAOSA	PZ6	 CONF. 2	18,50 €
M03547AB	12 ROTOLI CARTA IGIENICA MINI JUMBO ECOGREEN	PZ 12	 CONF. 2	18,10 €
G16573A	CARTA IGIENICA GOLD 3 VELI IN CONFEZIONE DA 8 ROTOLI	PZ 8	 CONF. 9	2,89 €
C26876AI	CARTA IGIENICA INTERCALATA 2V 225PZ	PZ 36	 CINF. 1	29,88 €
M11420C	CARTA IGIENICA ORO 3 VELI IN CONFEZIONI DA 12 ROTOLI	PZ 12	 CONF. 3	4,26 € 4,26 €
M21620C	GUANTI IN NITRILE NERI MISURE VARIE PZ 100	PZ 100	 CONF. 10	4,48 €

M25610AD	SACCHETTI SHOPPES BIO MINI 24X45	KG 4		CONF 10	17,88 €
C15795AE	SACCHETTI SHOPPERS BIO MEDI CON MANICI	KG 4		CONF. 3	22,80 €
M25719BH	SACCHETTI SHOPPES BIO MAXI 35X65	KG 6		CONF. 10	33,92 €
R03480C	SACCHI N.U 30X60 C/M BIANCHI ROTOLO 800G	800 Gr		CONF. 5	5,20 €
C03645A	SACCHI N.U 90X120CM AMBRA ROTOLO DI 800G	800 Gr		CONF. 5	2,85 €
C19006CM	SACCHI N.U 90X120/70X110 AMBRA 20KG	20KG		CONF. 2	52,50 €
M03251DB	SACCHI N.U 90X120 AMBRA CARTONE	Kg 18		CONF. 2	51,87 €
M01990M	SACCHI N.U NERI 70X110	PZ 10		1,50 € CONF. 24	1,25 €
G03187M	SACCHI N.U ECOSMART NERI 70X110 800 GRAMMI	800 Gr		CONF. 10	2,55 €
M02060A	SACCHI N.U 90X120 NERI 800 GRAMMI	800 Gr		CONF. 10	2,55 €
M10950CB	SACCHI N.U. COLORE NERO ESTESI 90X120	18KG		CONF. 2	39,82 €
G20831CM	SACCHI N.U. 90X120 NERI KG 20	20KG		CONF. 2	40,98 €
G26221CM	SACCHI N.U. 70X90 NERI KG 20	20KG		CONF.2	40,98 €
M27403M	SACCO NEUTRO/COLORATO N.U. 70X110 PZ 10	PZ10		CONF.28	1,58 €
C067071M	SACCHI N.U. 55X65 A ROTOLO COLORE AZZURRO O VARIE CON LACCIO N°15	PZ 15		CONF 30	1,20 €
M05900D	DETERGENTE PROFESSIONALE HACCP MANUALE PIATTI ESSENZA LIMONE	5 LT		CONF. 2	6,24 €
M06054AC	DETERGENTE PER LAVASTOVIGLIE PROFESSIONALE HACCP CONCENTRATO	5 LT		CONF. 2	18,15 €
M06100I	BRILLANTANTE PER LAVASTOVIGLIE HACCP PROFESSIONALE	5 LT		CONF. 2	14,30 €

M12730AB	SGRASSATORE GRILL PIASTRE E FORNI	5 LT		CONF. 2	26,00 €
M06275D	DETERGENTE IGIENIZZANTE PROFESSIONALE PER PAVIMENTI HACCP	5 LT		CONF. 2	7,20 €
C06365B	CANDEGGINA CONCENTRATA HACCP PROFESSIONALE	5 LT		CONF. 2	4,62 €
M10660AB	CIF DETERGENTE PROFESSIONALE PER SUPERFICI IN LEGNO HACCP	5LT		CONF.2	17,50 €
C12688D	PELLICOLA ESTENSIBILE PER IMBALLAGGI TRASP	2,2KG		CONF. 6	7,25 €
M12010H	PAGLIETTA INOX DA 60 GR	PZ 12		CONF. 20	11,10 €
M12160B	SPUGNA PROFESSIONALE ERGONOMICA	PZ 10		CONF.24	4,00 €
M12270M	SPUGNA MAXI LATO ABRASIVO	PZ 6		CONF. 36	2,00 €
G22079D	PANNI IN SPUGNA 18X16,5 CM 5 PEZZI	PZ 5		CONF. 10	2,99 €
M06863B	LYSOFORM IGIENIZZANTE CUCINA PROFESSIONALE 750ML HACCP	750 ML		CONF. 6	3,63 €
M10415A	ANTICALCARE SPRAY PER VARI SUPERFICI CUCINA / BAGNO 750 ML	750 ML		CONF. 12	1,99 €
M06900AB	DETERGENTI IGIENIZZANTI PER VARI SUPERFICI RESISTENTI ALL'ACQUA SOLO A CONFEZIONE DA 6	750 ML		CONF. 6	18,50 €
M12345B	SGRASSATORE PROFESSIONALE IGIENIZZANTE SPRAY	750 ML		CONF. 6	3,10 €
M10316A	SGRASSATORE PER SUPERFICI PROFUMO LIMONE	750 ML		CONF. 6	1,99 €
M10104B	SPRAY MULTIUSO PROFESSIONAL CONCENTRATO PER VETRI E SUPERFICI 750 ML	750 ML		CONF. 6	2,69 €

M10215A	DETERGENTE SPRAY VETRI CON ALCOOL 750 ML	750 ML		CONF. 6	2,15 €
M11114D	SAPONE LIQUIDO MANI PROFESSIONAL HACCP CON GLICERINA	5LT		CONF. 2	6,35 €
M11920AF	DEO DEODORANTE PER AMBIENTI SPRAY	750 ML		CONF. 6	19,30 €

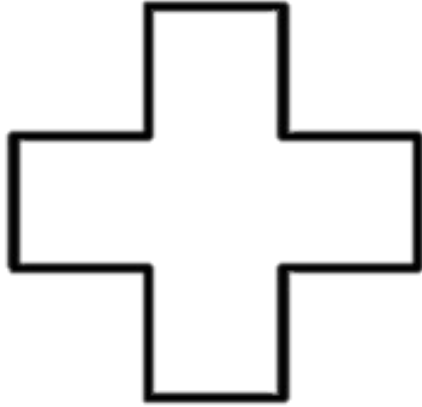



SANTTA'

**IL TUO
PREZZO
IVATO**



COD.	PRODOTTO	CONF.	QUANTITA PER CARTONE	
M12952A	CUFFIE MONOUSO ELASTICIZZATE IN TNT BIANCHE 52CM	PZ 100	 CONF. 20	1,98 €
M12486B	CUFFIE RACCOGLI CAPELLI IN TNT BLU/NERO	PZ 100	 CONF. 10	3,82 €
M12500H	MASCHERINA CHIRURGICA MEDICAL PIU	PZ 50	 CONF. 8	9,45 €
M12630D	MASCHERINA FFP2 A BUSTA SINGOLA	PZ 100	 CONF.7	5,80 €
M12750D	GUANTI IN LATTICE SENZA POLVERE MISURAS/M/L	PZ 100	 CONF. 10	5,90 €
M12895A	BAVAGLIO MUNITO DI TASCA IN CARTA E POLIETILENE MONOUSO	PZ 50	 CONF. 20	2,60 €
M12996H	MANTELLINA IN CARTA POLITENATE 50X80CM	PZ 60	 CONF. 6	10,92 €
M13087D	BAVAGLIO MUNITO DI TASCA MONOUSO 37X66CM	PZ 100	 CONF. 9	6,15 €
M13172A	COPRIMANICHE LDPE MONOUSO 40X20	PZ 100	 CONF. 20	2,50 €
M13280B	COPRISCARPE POLIPROPILENE MONOUSO	PZ 100	 CONF. 20	3,80 €
M13360A	COPRISCARPE IN POLIETILENE MONOUSO	PZ 100	 CONF. 40	2,30 €
M13465A	MANOPOLE IN TNT PRESAPONATE	PZ 20	 CONF. 50	2,08 €
M13501B	MANOPOLE TNT POLITENATE BIANCHE	PZ 50	 CONF. 20	2,60 €

M13650B	SALVIETTE TNT 30X38 BIANCHE	PZ 100		CONF. 12	3,15 €
M13788D	GUANTI IN NITRILE COLORE NERO 3,5Gr NO FOOD	PZ 100		CONF. 10	5,88 €
M13858M	GHIACCIO INSTANTANEO MONOUSO	PZ 1		CONF. 25	1,00 €

Le immagini utilizzate sono da intendersi puramente illustrative.

